

Montagewagen Utility Cart

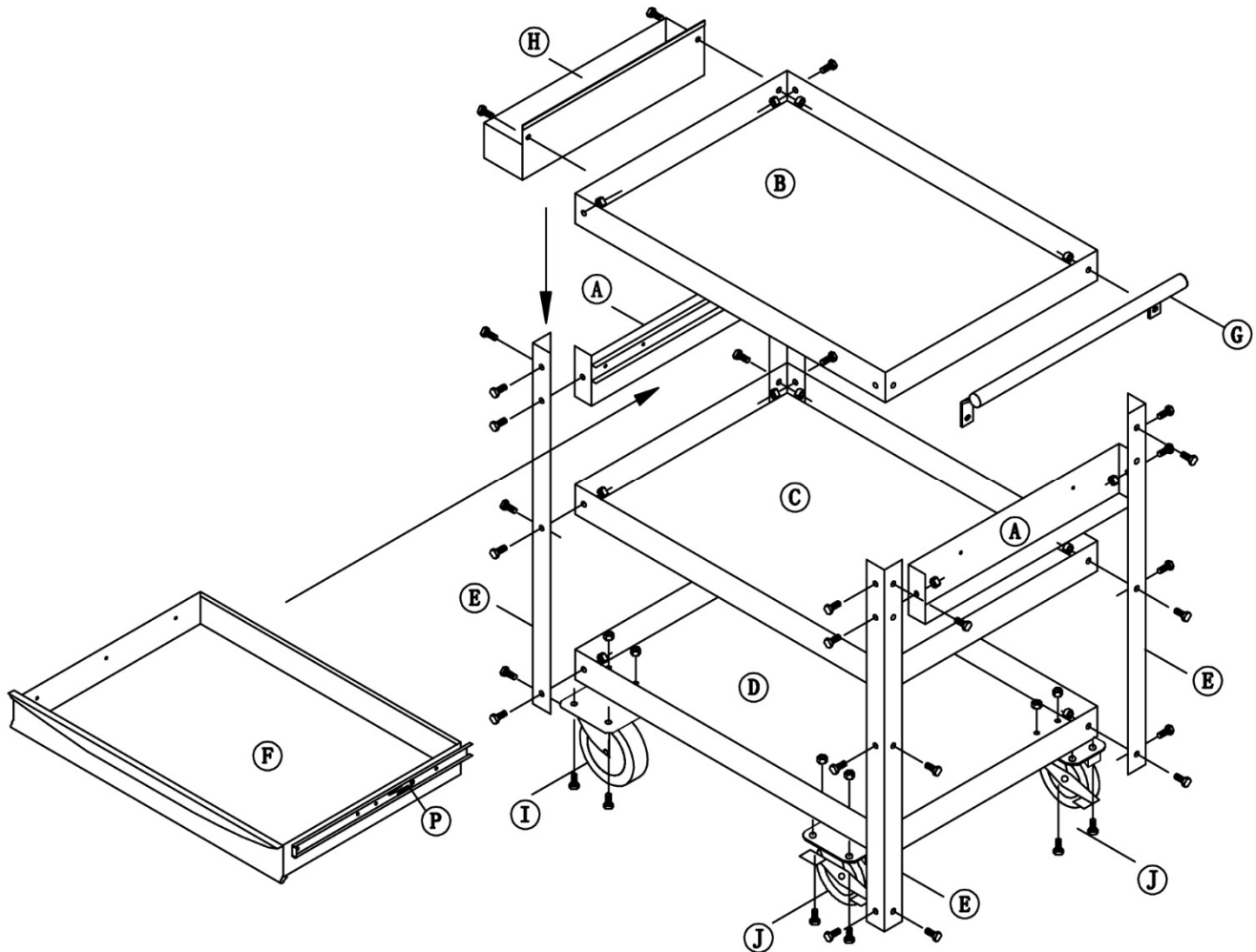









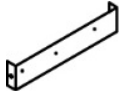
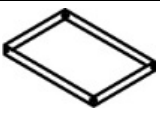
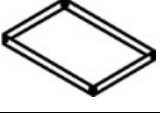
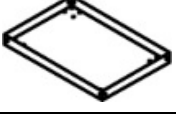

Spezifikationen

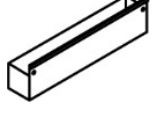
Höhe: 830 mm
Belastbarkeit: 150 kg
Schublade ausziehbar, belastbar bis zu 25 kg

Specifications

Height: 830 mm
Capacity 150 kgs
Drawer is extendable, capacity up to 25 kgs

		Teilename Part Name	Stk. Pcs.
A		Schienenblech Box Trace	2
B		Obere Platte Top Plate	1
C		Mittlere Platte Middle Plate	1
D		Untere Platte Bottom Plate	1
E		Winkelpfosten Angle Steel Post	4
F		Schublade Drawer	1
G		Seitengriff Side Handle	1
H		Seitliche Ablage Side Tray	1
I		Rollen 100x32 mm Fixed Caster 4x1.25"	2
J		Lenkrollen 100x32 mm Swivel Caster 4x1.25"	2
K		Sechskantschraube Hex Bolts	44
L		Stopmutter Nylon Nut	46
M		Unterlegscheibe Washer	46
N		Sechskantschraube Hex Bolts	2